

SAFARI 1D1W

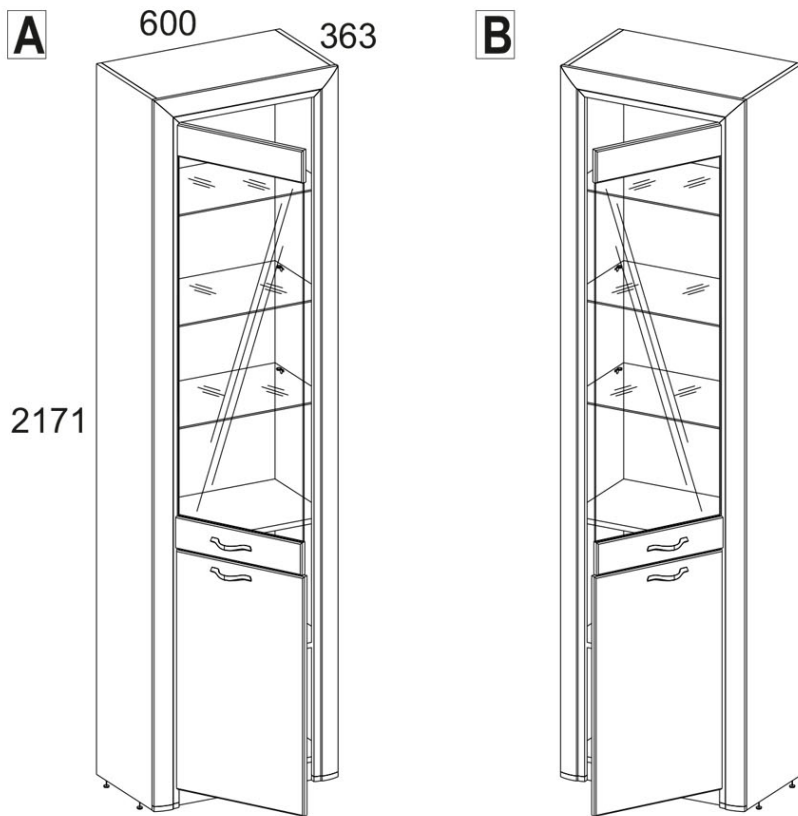

Koda	L, mm	B, mm	H, mm		paket
1	566	335	16	1	1/4
2	566	335	16	2	1/4
3	564	335	16	1	1/4
4	564	325	6	3	1/4
6	2166	335	16	1	2/4
7	2166	335	16	1	2/4
8	2152	80	25	1	3/4
9	2152	80	25	1	3/4
10	600	80	25	1	3/4
11	1294	436	16	1	2/4
12	436	730	16	1	2/4
13	1374	592	2,5	1	4/4
14	730	592	2,5	1	4/4
25	566	55	16	1	3/4

Pri uporabi pohištva je prepovedano:

- postavljati pohištva v bližino grelnih naprav in ob vlažne stene ter v prostore z relativno vlažnostjo nad 70 %;
- temperatura ogrevanja pohištvenih elementov ne sme presegati + 40 °C;
- med sestavljanjem in uporabo pohištva ne stojte z nogami na vodoravnih ploščah in oknih;
- za čiščenje pohištva ne uporabljajte kemičnih čistilnih sredstev;
- ne sme biti izpostavljeno vodi.

VONJ.

Novo pohištvo lahko oddaja vonj po materialih, iz katerih je izdelano. Vonj se lahko ohrani do tri tedne po namestitvi. Da bi zmanjšali intenzivnost vonja, je priporočljivo, da:

- pri oblaženem pohištvu - izdelek posesajte in prezračite prostor.

Ponovite 3-4-krat na dan.

-pri omarah - obrišite s krpo, navlaženo z blagim detergentom, obrišite s čisto, suho krpo in prezračite prostor ter najprej odprite vsa vrata in predale izdelka.

Ponovite 3-4-krat na dan. Pomembno! Navodila shranite za primer ponovnega sestavljanja pohištva ali reklamacij.

Pri vložitvi reklamacije uporabite oznake, ki so navedene v navodilih.





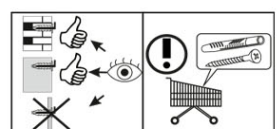
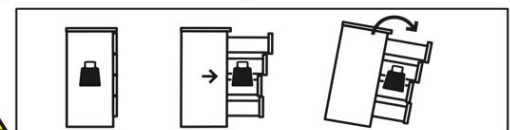

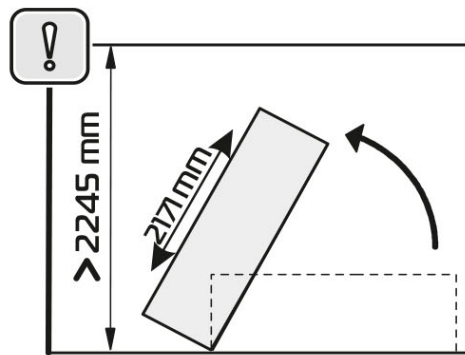
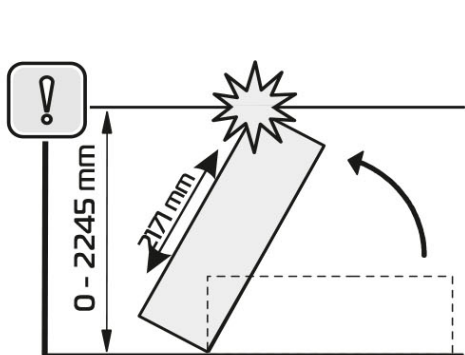
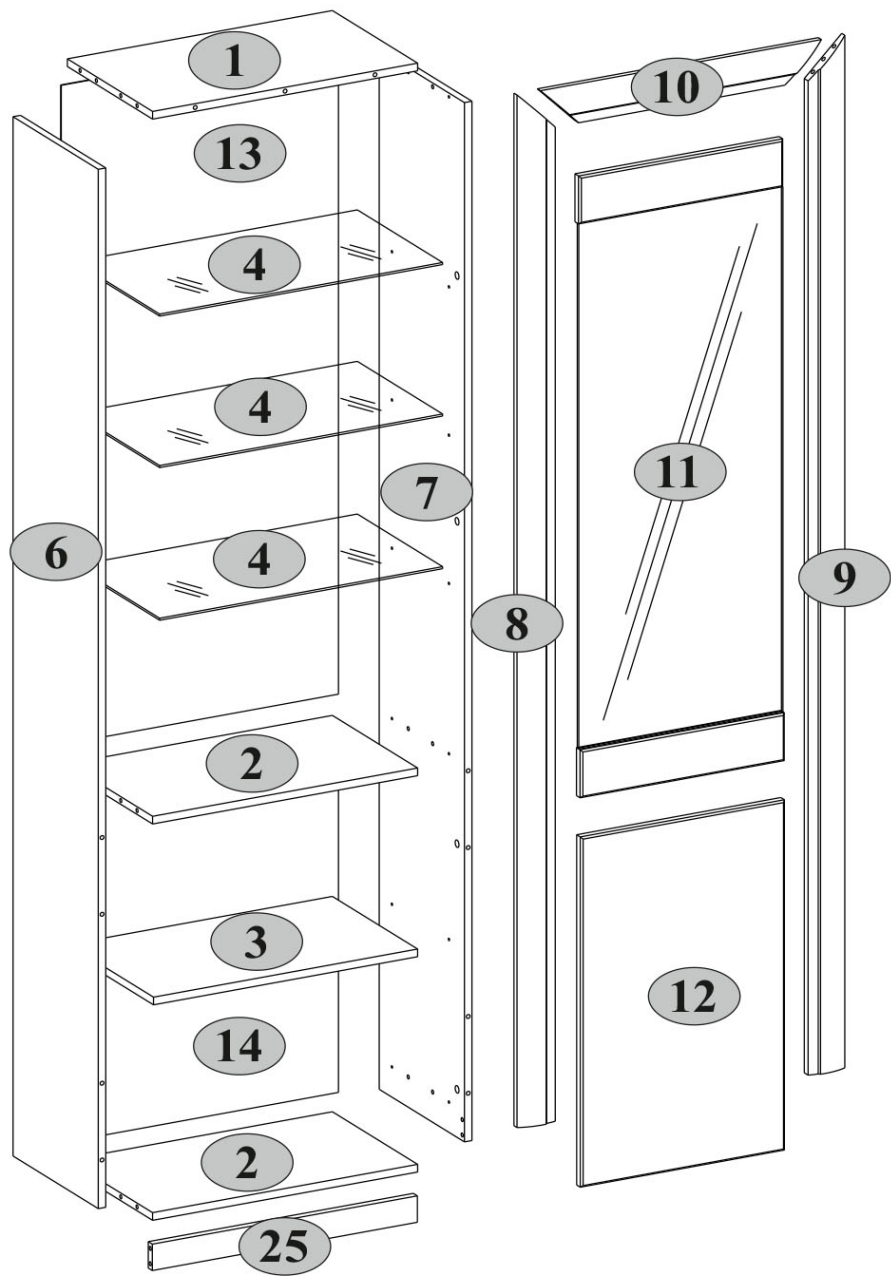

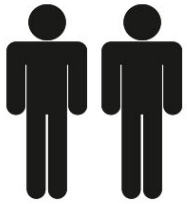



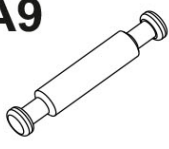

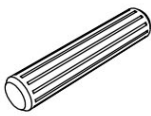
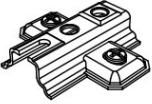
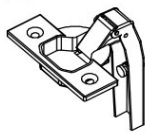

OPOZORILO! Padec kosa pohištva lahko zaradi zdrsa povzroči hude ali smrtne poškodbe. VEDNO pritrdite ta kos pohištva na steno z pritrilnimi elementi. Za opečne in betonske stene se uporablja vgrajeni zatič. Za pritritev na steno uporabite pritrilne elemente, primerne za material stene; če niste prepričani, katera vrsta pritrilnih elementov je primerna za material stene, se obrnite na strokovnjaka ali specializirano trgovino. Za pritrilne elemente je na koncu odgovoren izvajalec montaže. Za dodatno zmanjšanje tveganja hudih telesnih poškodb in smrti zaradi padca pohištva:

- Najtežje predmete položite v spodnji predal.
- Težkih predmetov ne postavljajte na zgornji del predala.
- Nikoli ne dovolite otrokom, da plezajo po predalih, vratih ali policah.
- Pohištvo uporabljajte v skladu s predvidenim namenom

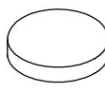



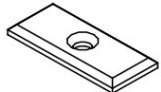

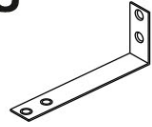
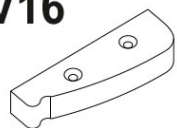

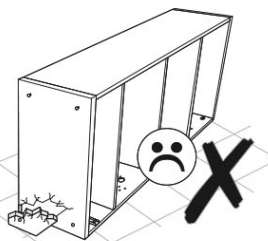
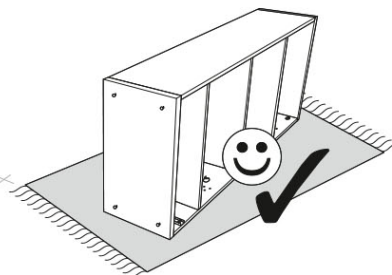
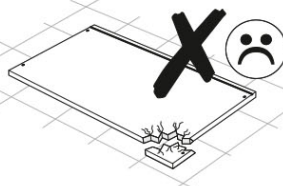
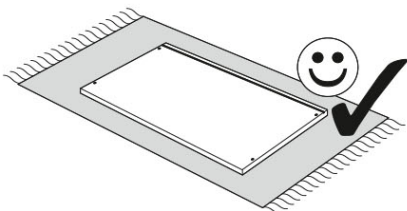
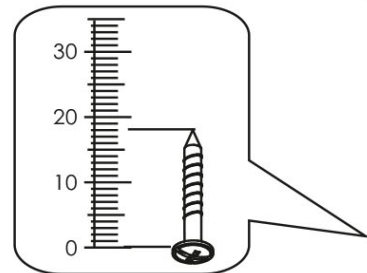
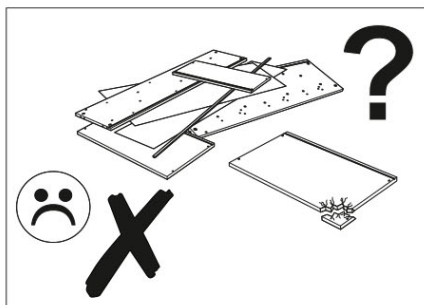
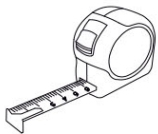
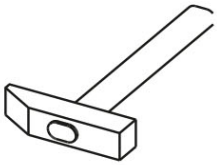
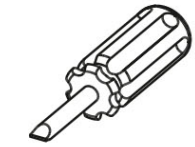
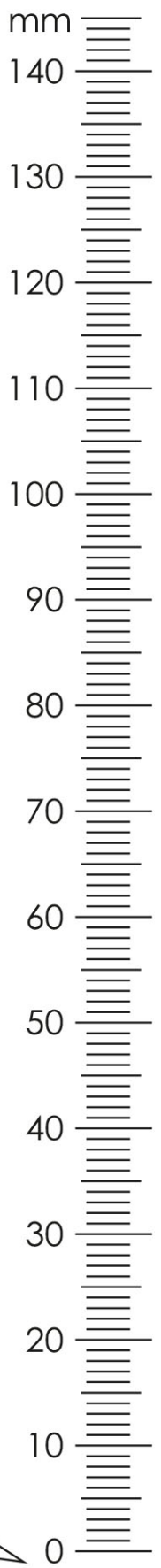

A1.0  5x28 22	A2  15x13 26	A9  L-47,4 2	B5  10x50 1
C1  8x35 29	D1  4	E2  4	G  1,5x26 36
H63  2	M4  M4x22 4	N1  4	P1  Ø5 4
P4  12	Q  1,5x7 2	R3  3x20 2	R5  3x30 4
R23  6,3x13 8	R102  3,5x16 10	S3  2	S5  Ø18 18
U  130x35x15 1		V16  80x25x15 2	



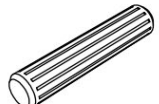

1

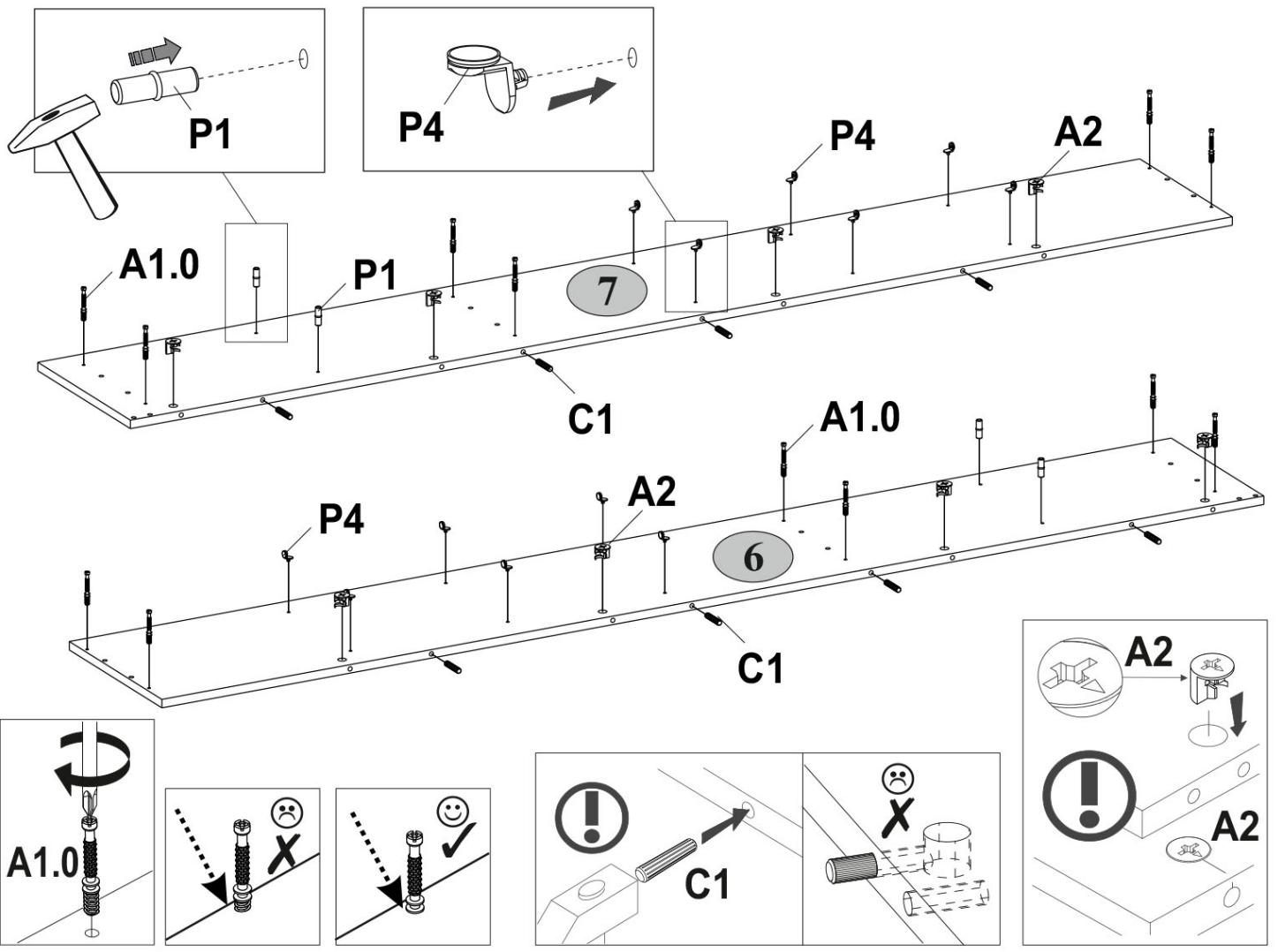
A1.0  5x28 12	A2  15x13 8	C1  8x35 8	P1  Ø5 4	P4  12
--	--	---	--	--

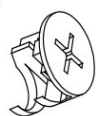

2

A2  15x13 6	C1  8x35 5
--	---

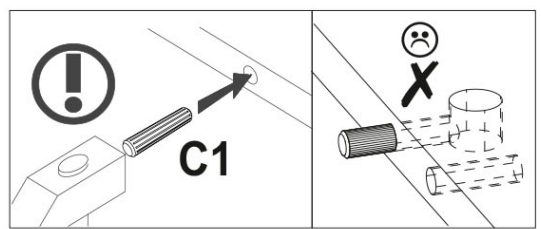
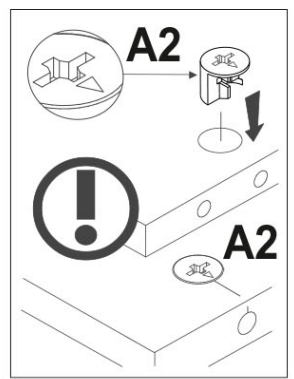
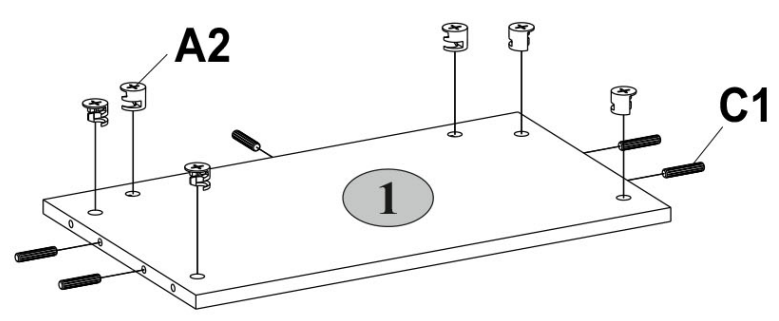

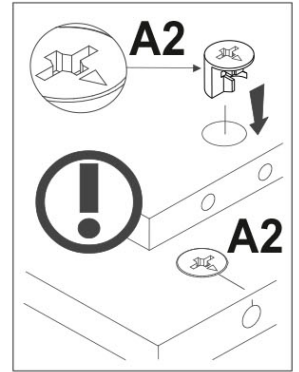
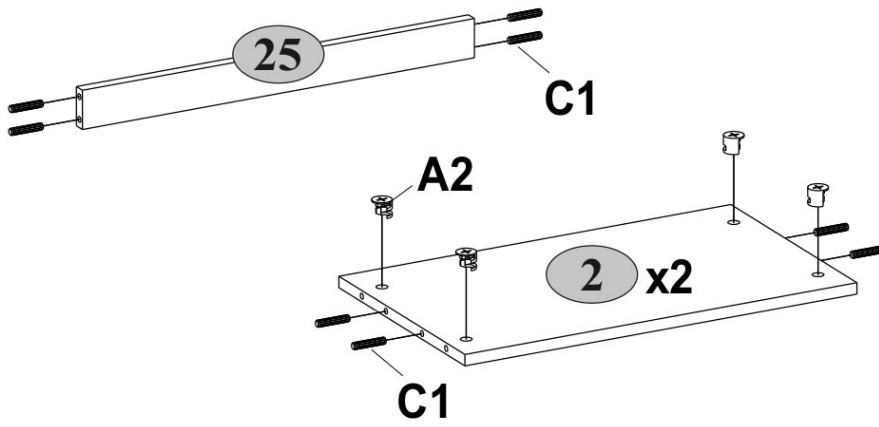
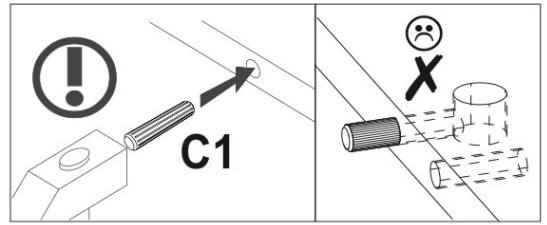
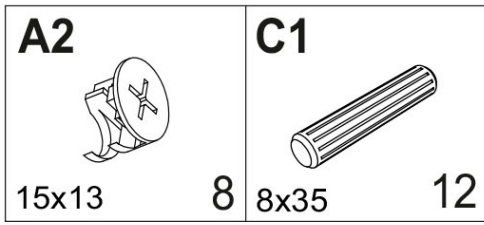

3

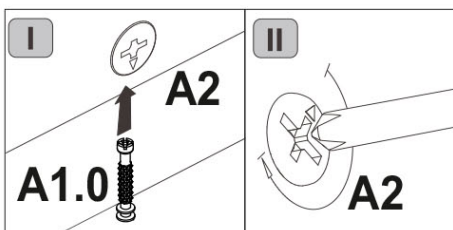
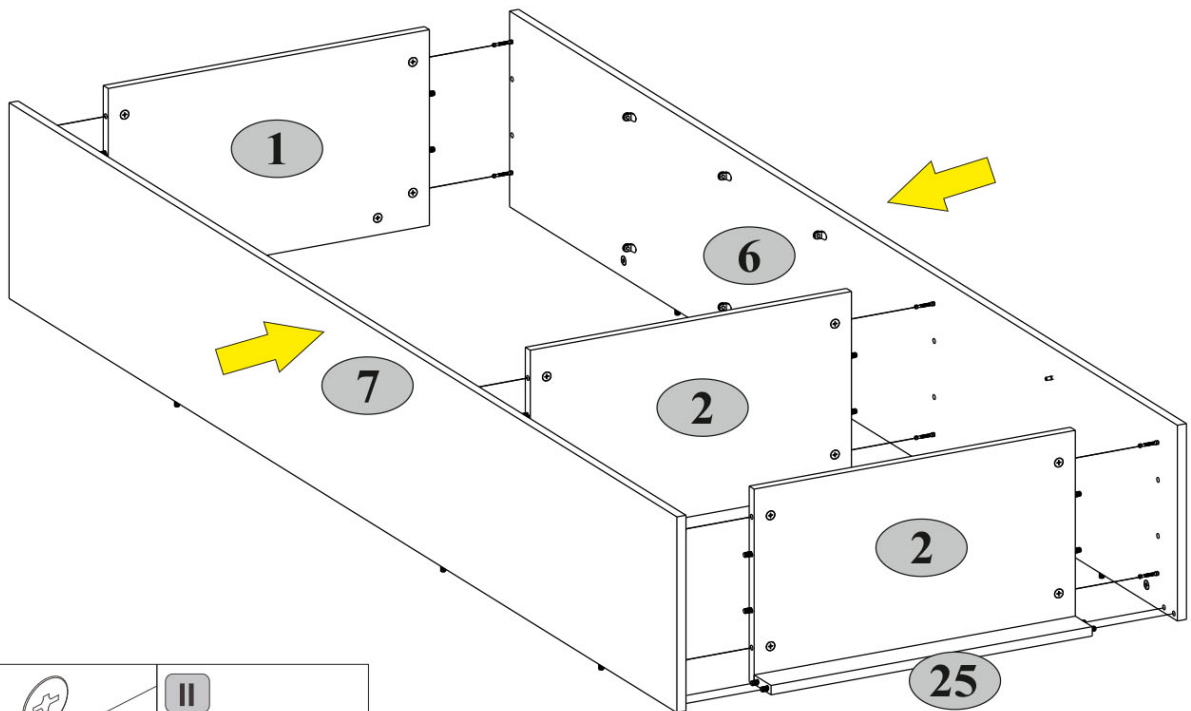

4





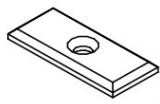

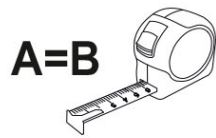
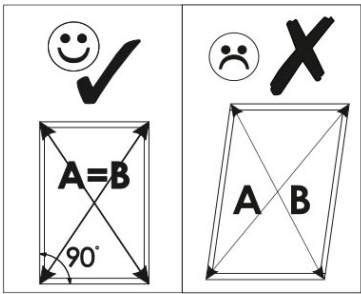
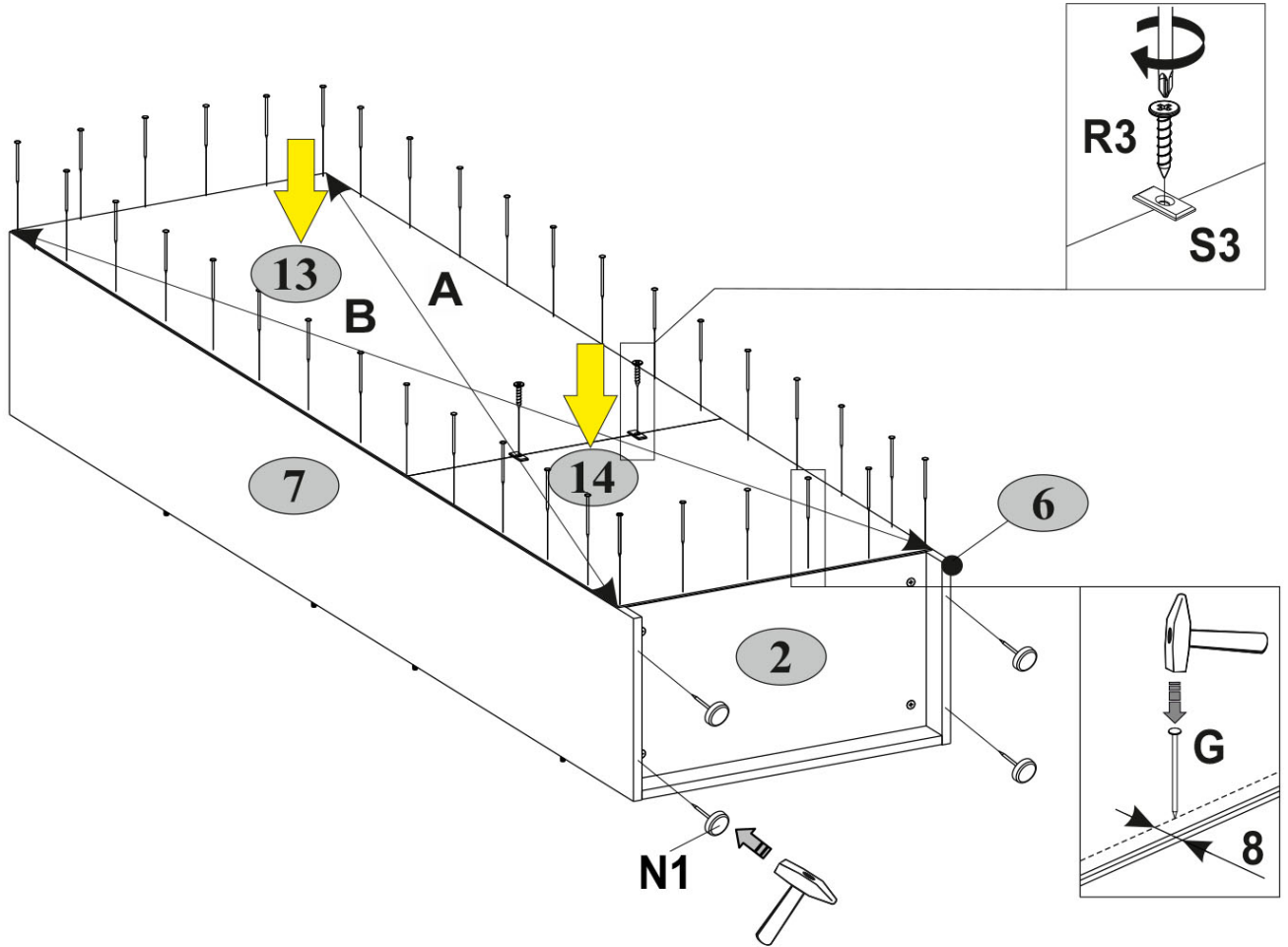
5

G  1,5x26 36	N1  4	R3  3x20 2	S3  2
---	---	---	--

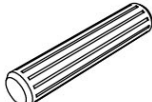

6

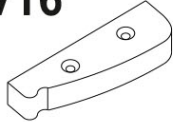

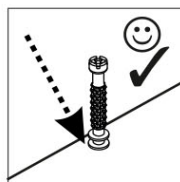
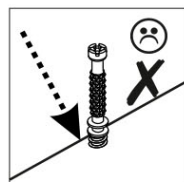
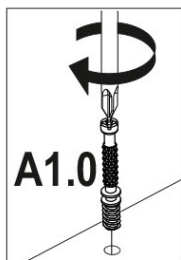
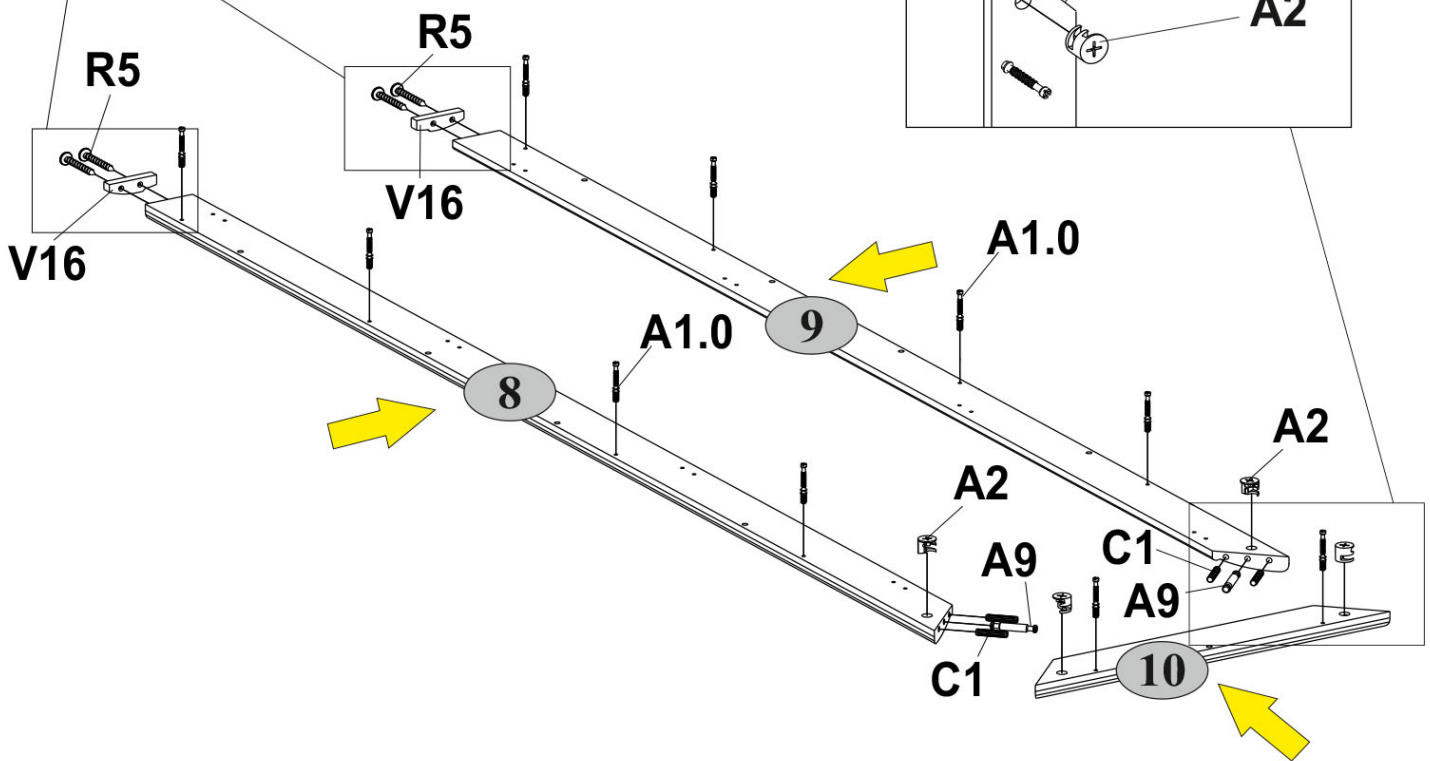
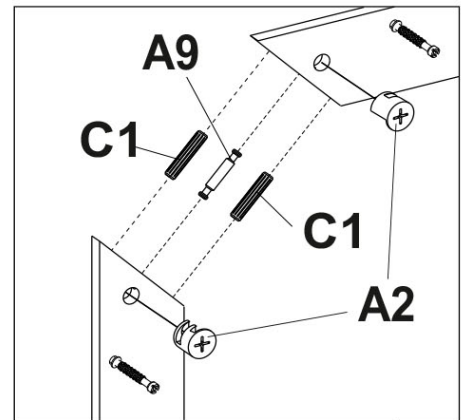
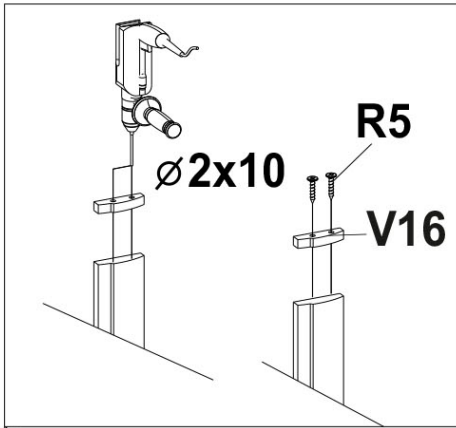

A1.0  5x28 10	A2  15x13 4	A9  L-47,4 2	C1  8x35 4	R5  3x30 4	V16  80x25x15 2
---	---	--	---	--	---

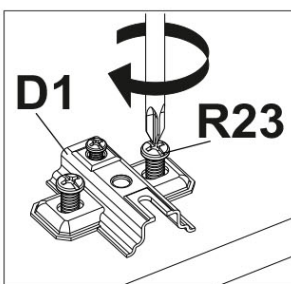
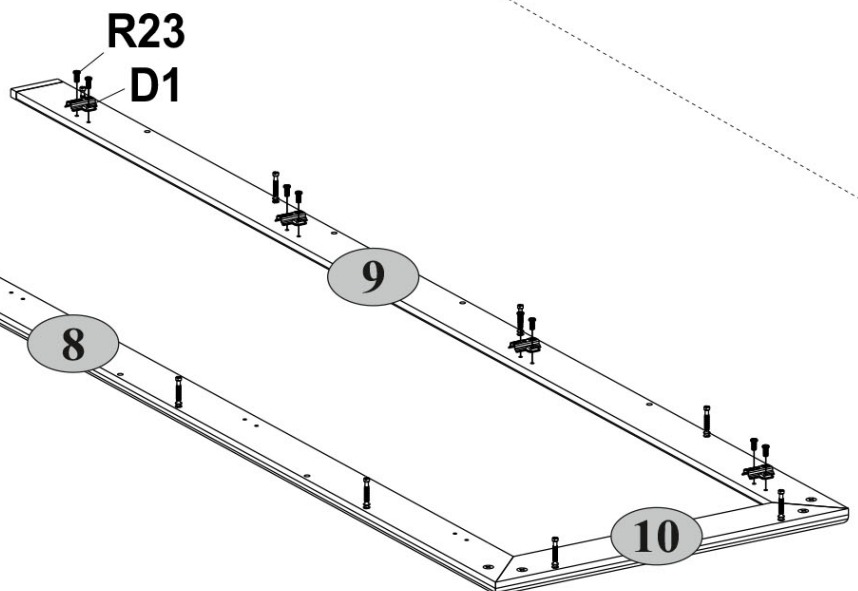
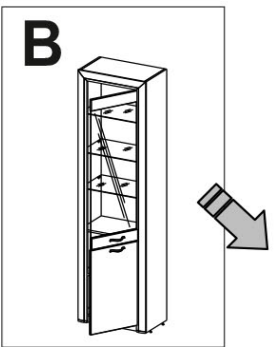
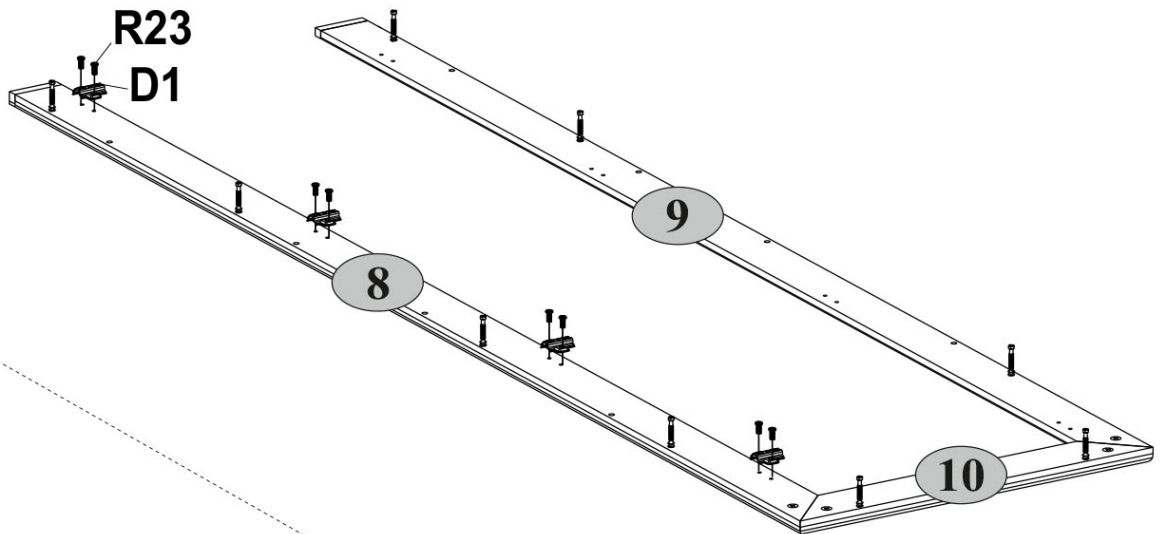
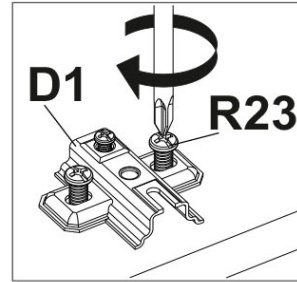
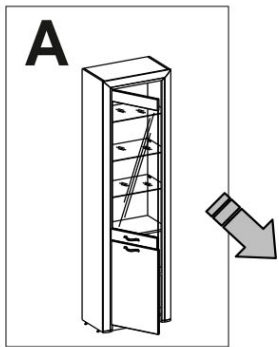
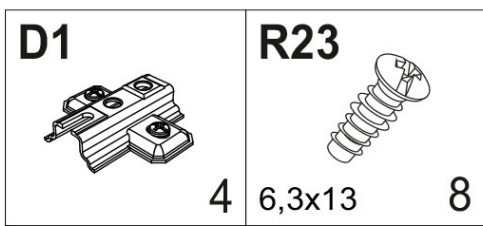

7

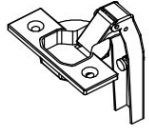

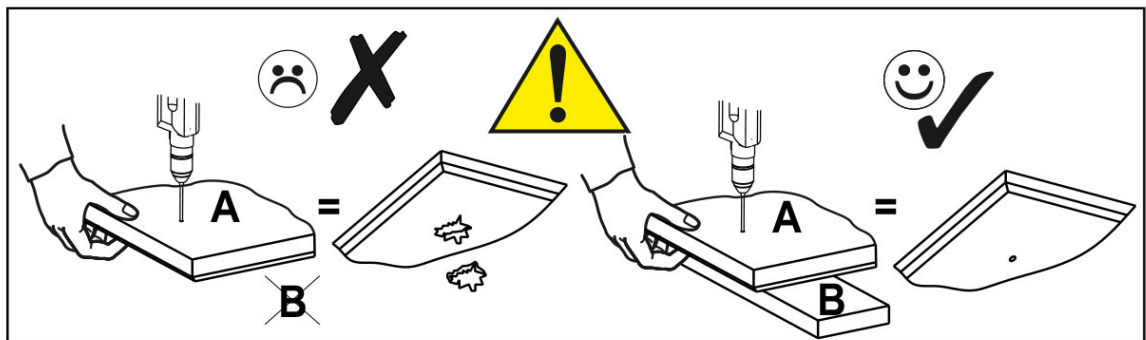
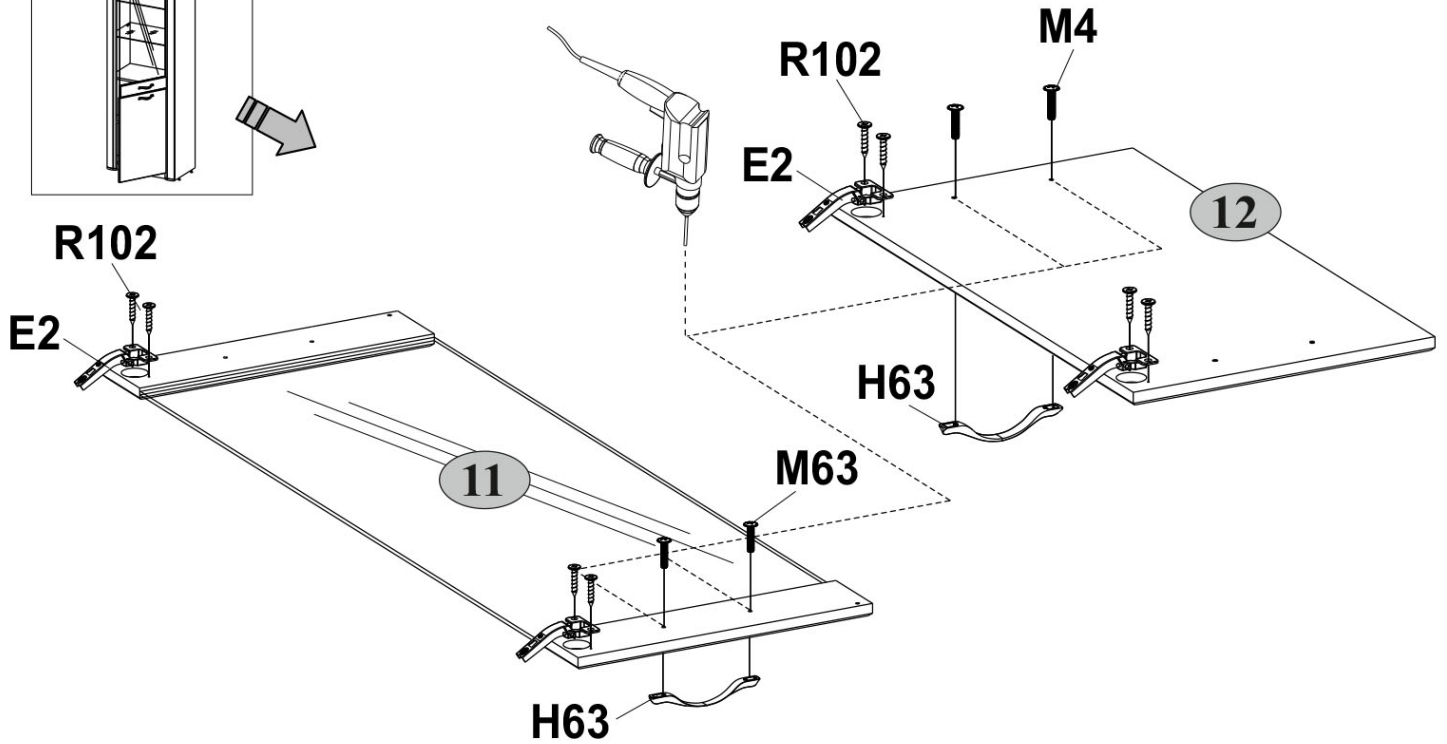
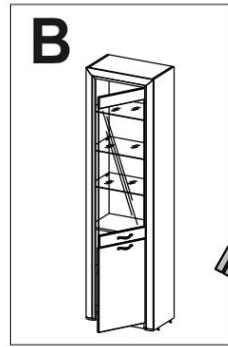
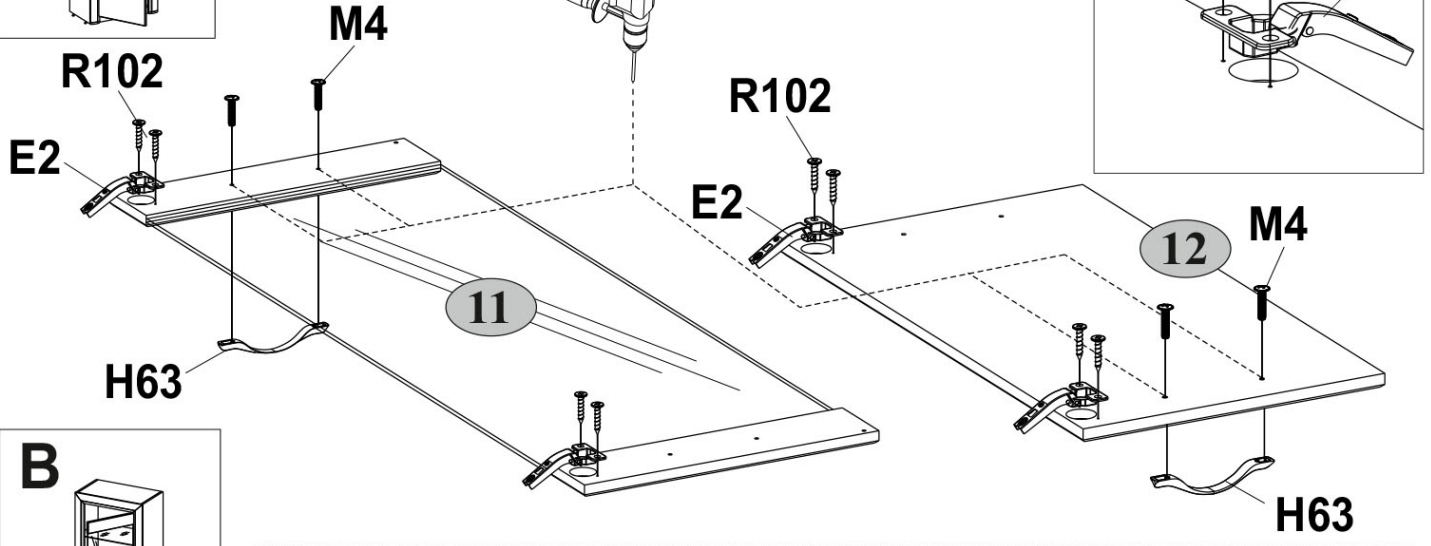
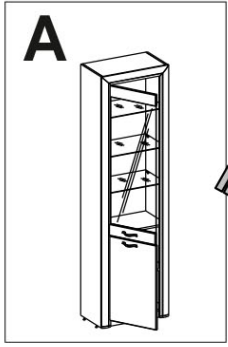

8

E2  4	H63  2	M4  M4x22 4	R102  3,5x16 8
---	--	---	--



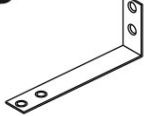

9

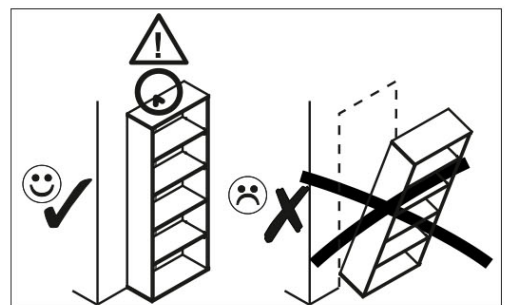
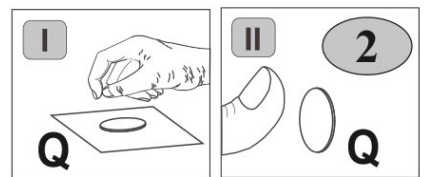
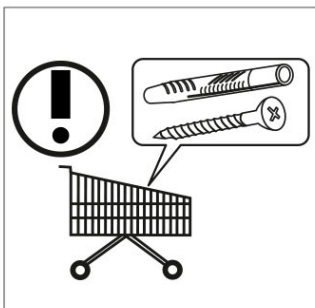
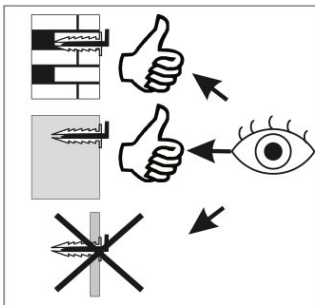
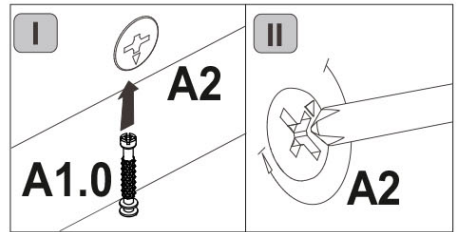
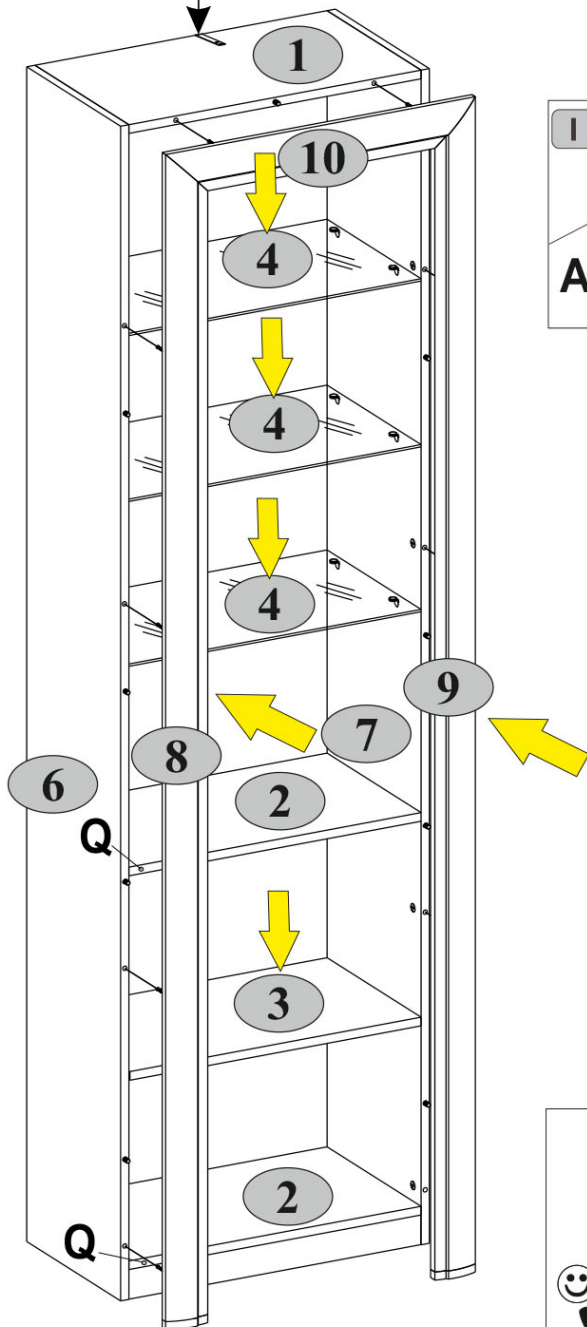
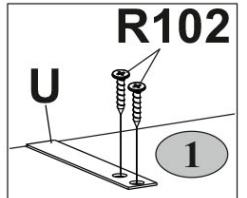
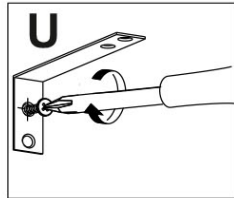
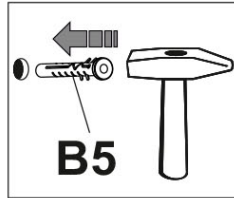
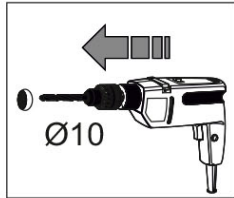
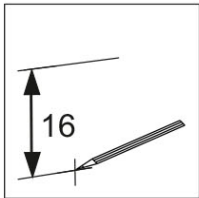
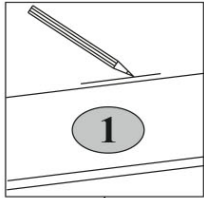
B5  10x50 1	U  130x35x15 1	Q  1,5x7 2	R102  3,5x16 2
--	---	---	---

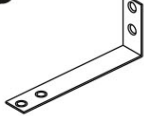

9

B5  10x50 1	U  130x35x15 1	Q  1,5x7 2	R102  3,5x16 2
--	---	---	---

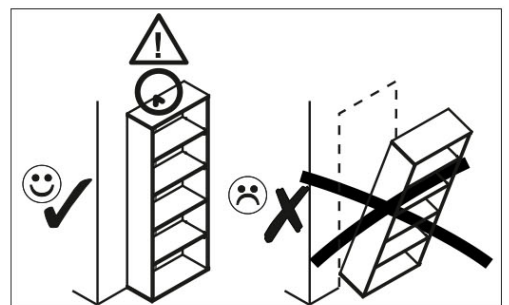
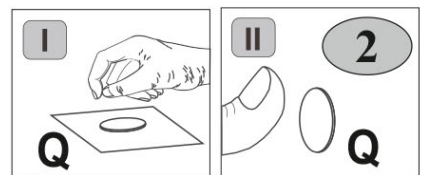
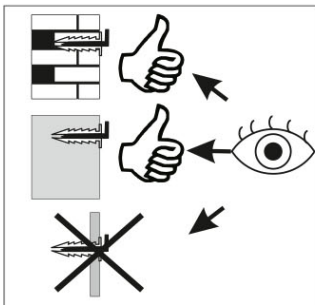
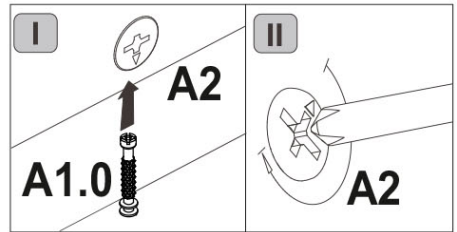
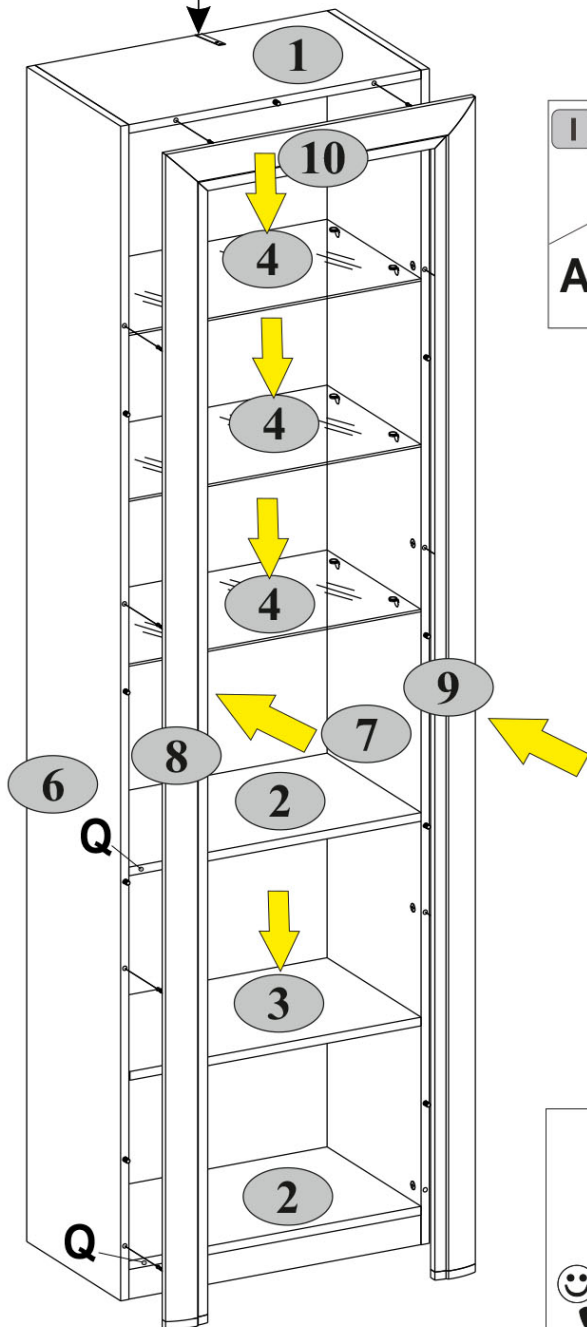
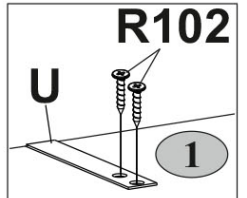
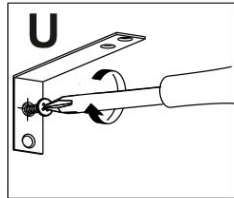
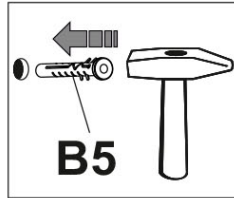
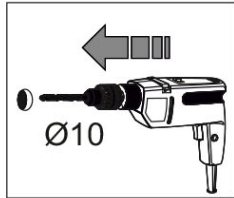
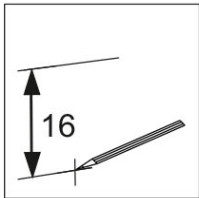
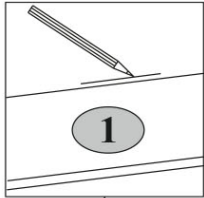

10

S5

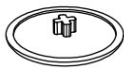

Ø18

18

A

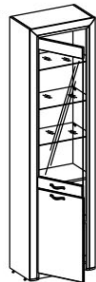

B

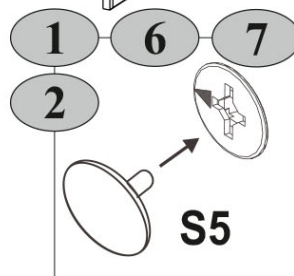
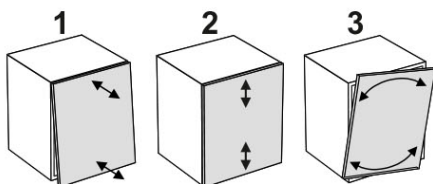
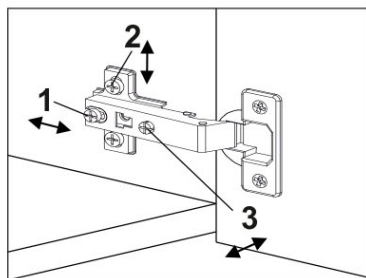
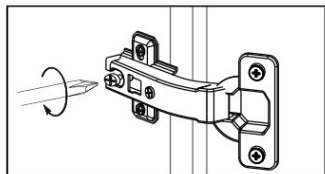
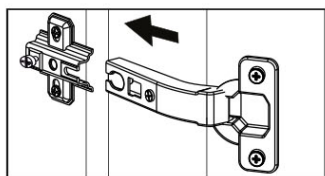
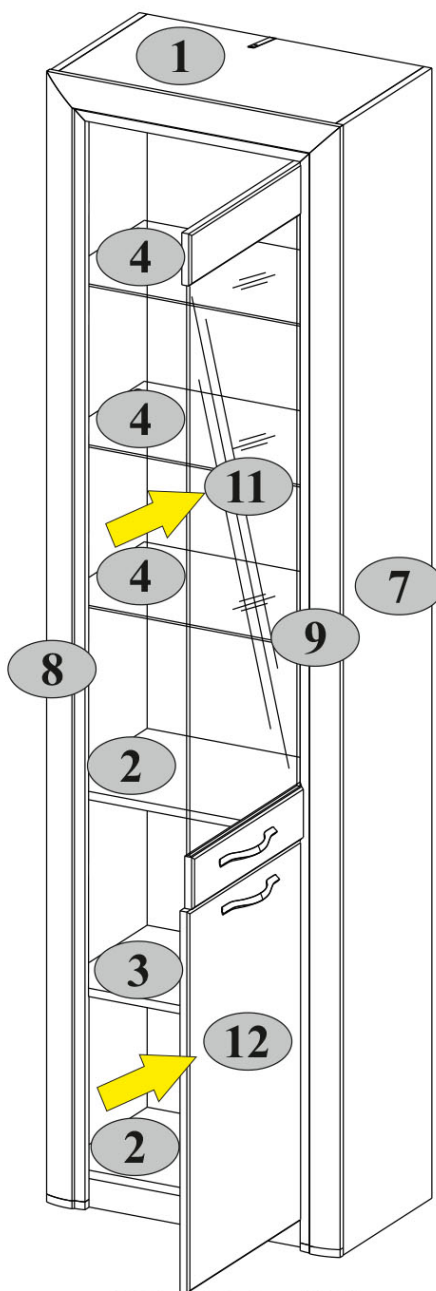
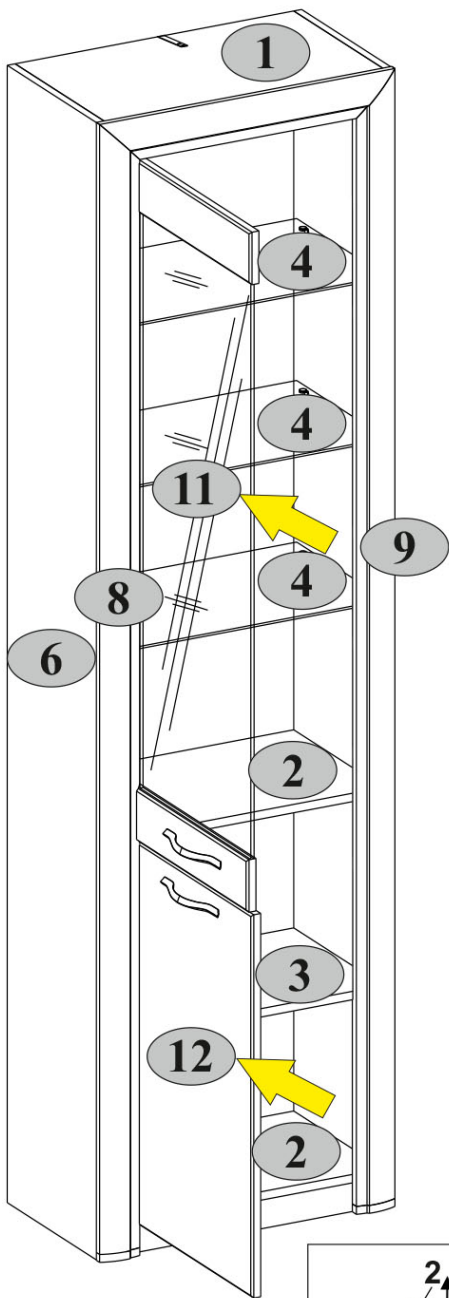
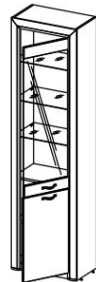

**max.
5 kg**